



2024



# CATALOG

## SMART VENDING MACHINES

# AVANGARD

F U S I O N   V E N D I N G



**PERFECTION** in every  
vending **SOLUTIONS.**  
Innovation. Customization. Time.

*Since 2003*



# AVANGARD

F U S I O N   V E N D I N G



## CONTENT

About AVANGARD .....	4
Product advantages .....	6
Proprietary software .....	8
Lift .....	10
Crystal .....	12
Link .....	14
Link Glass .....	16
AXON .....	18
Vape machines .....	19
Touch 10, 19 .....	20
Smartshop .....	22
Smartfoodcourt .....	23
Customized solutions .....	24





# ABOUT **AVANGARD**

AVANGARD is a Ukrainian manufacturer specializing in full-cycle production of vending machines and payment terminals. With 20 years of experience, we provide innovative and reliable solutions across 9 European countries. From design to software, our comprehensive manufacturing process ensures top-quality products that enhance your business.

## **OUR MISSION**

**CREATE A CONVENIENT AND EFFICIENT FUTURE.**

Where every person can take what they needs here and now, enjoying life, without wasting time waiting!

We are committed to a future where shopping is fast, easy and enjoyable. We keep improving our products to provide the best customized solutions in automated trading.

AVANGARD is part of the Karbon Group of companies, established in 1997, a leader in Ukraine's telecommunications and energy markets.

## **WHAT SETS US APART?**

At Avangard, we stand out from other vending machine manufacturers because we don't just sell standard models. All our machines are fully customizable and can be tailored to the needs of your business.

Our in-house manufacturing capabilities allow us to directly control product quality at every stage of production, from raw material selection to the finished product. Our commitment to quality is backed by ISO and CE certifications.



Video



# OUR **PROJECTS**





# PRODUCT **ADVANTAGES**

The AVANGARD model range is represented by 5 lines of modular trading machines. They easily combine with each other to create a complex of automated sales (smartshop).



## **FUNCTIONAL**

- Possibility to connect up to 32 vending machines to payment module/master machine
- Cash/non-cash contactless payment
- Simultaneous purchase of several items
- Elevator and refrigerator options
- Remote control system, telemetry
- Multilingual user-friendly interface
- Touch monitor, broadcasting commercials
- Integration with other IT systems



## **MACHINE BODY**

- Anti-vandal protection – 1.0-1.2 mm thick steel body, special lock design, anti-phishing system
- Powerful double-chamber tempered glass
- Reliability – internal mechanism with a galvanic covering, stainless steel elements, an anticorrosive powder covering



We've assisted more than **650** clients, both with standard solutions and unique ones, which have resulted in a positive synergy of collaborative work with the client across **9** countries worldwide. Over the span of these two decades, we've successfully manufactured and delivered more than **20,500** devices, providing support during and after the warranty period.

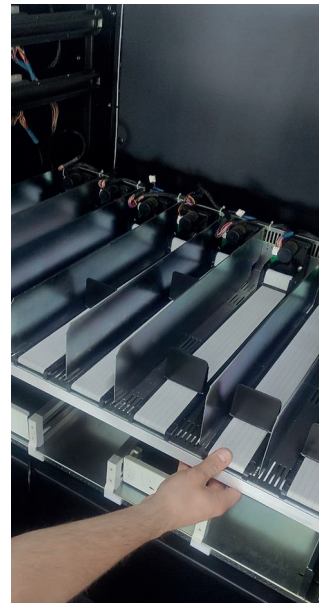

**СЕРТИФІКАТ**

**ДСТУ ISO 9001:2015 (ISO 9001:2015, IDT)**

ОС „УкрБудСЕРТ” ТОВ „РАКУРС ЛІД” підтвержує, що система управління якістю

**ТОВ «АВАНГАРД»**

Сфера сертифікації:  
Проекування, виробництво та монтаж електродистанційного обладнання, торговельних автоматів, терміналів, блок-контейнерів, електричних та телекомунікаційних шаф, електромонтажних пристроїв  
Код ДКПН за ДК 016-2010: 28.29.43, 27.12.1, 27.12.2, 27.33.1, 28.23.13, 26.20.1, 43.21.1, 71.12.1

Адреса:  
Україна, 08132, Київська область, Києво-Святошинський район,  
с. Петрівське, вул. Київська, 29  
Код ЄДРПОУ 32549659

Відповідає вимогам ДСТУ ISO 9001:2015 (ISO 9001:2015, IDT) «Система управління якістю. Вимоги. Сертифікат видано на підставі звіту про оцінку системи управління якістю від 19.07.2023 та рішення про висування № 0054СУ-9-23/ від 19.07.2023  
Комплексні перевірки сертифікаційної системи управління якістю відповідно до вимог стандарту здійснюються шляхом проведення типових наглядів один раз на рік.

Сертифікат дієвий з 19.07.2023 до 18.07.2026

Зареєстрований у Регистрі Систем сертифікації «УкрБудСЕРТ» за номером: 80035.254-23

МП  
Керівник органу сертифікації  
СНАЙКО Наталія

ОС „УкрБудСЕРТ” ТОВ „РАКУРС ЛІД”, 09032, м. Золотоша, пр. Сабуровий, 178-р, 32, <http://rakurslid.com>  
Листів акредитації №80035, зареєстрований в Регистрі НАУ 28.11.2019 року  
\*Написи, сертифікату можна переглянути в Регистрі ОС „УкрБудСЕРТ” за тел.: (067) 413-12-01

Form QAT\_10-M05, version 03, effective since June 19th, 2022

**CERTIFICATE**

No. 00240716.AQU96

Certificate's Holder: Limited Liability Company "Avangard"  
29, Kyivska str., v. Petrivske, Kyiv region, 08132, Ukraine

Certification ECM Mark:

Product: Vending Machine  
Logo: Avangard  
Model(s): BWS-01, ALM-03, AVL-01, AVL-02, APT-102, APT-102M1, APT-102M2, APT-102M3

Verification to: Standard:  
EN 60335-1:2012/A15:2021,  
EN 60335-2-75:2004/A12:2010, EN IEC 61000-6-1:2019,  
EN IEC 61000-6-3:2021

related to CE Directive(s):  
2014/35/EU (Low Voltage)  
2014/30/EU (Electromagnetic Compatibility)

**Remark:**  
The manufacturer has voluntarily decided to submit its documents concerning the above-mentioned product for verification. Ente Certificazione Macchine confirms that the documentation made available and immediately related to it, as containing sensitive data, meets the essential requirements of the above-mentioned directive/standard. The verification activity carried out exclusively concerned the technical documentation and no verification was carried out on the product. This document cannot replace the EC Declaration of Conformity. This document was issued in accordance with regulation ISO/IEC 17067 published on the website of [www.entecertmacchine.it](http://www.entecertmacchine.it) and concerning voluntary certifications with a non-notified procedure.

Issuance date: 16 July 2024  
Expiry date: 15 July 2029

For online checks:

Approver: Ente Certificazione Macchine  
Legal Representative  
Luca Scaramelli

Ente Certificazione Macchine Srl  
Via Col. Ballo, 243 - Loc. Castello di Senavalle - 40053 Valsamoggia (BO) - ITALY  
☎ +39 051 4705141 | ✉ +39 051 4705156 | info@entecertmacchine.it | www.entecertmacchine.it



# PROPRIETARY SOFTWARE

AVANGARD Atomic SW – fully secured software, developed by AVANGARD specialists.

Our software is always bundled with the vending machine, information or payment machine itself and is absolutely free for the future owner.



## FUNCTIONAL

- Data transmission in real time
- Monitoring of product balances
- Sales monitoring, reporting
- Remote price change
- Remote goods dispensing
- Event log for each machine
- Control of temperature and storage terms
- Remote management of advertising and product information
- Marketing statistics

In contrast to the typical vending machines out there, AVANGARD machines offer a multi-purchase feature, enabling customers to grab several items in just one go.

The only limitation will be the delivery tray, so that the buyer can comfortably pick up his goods.

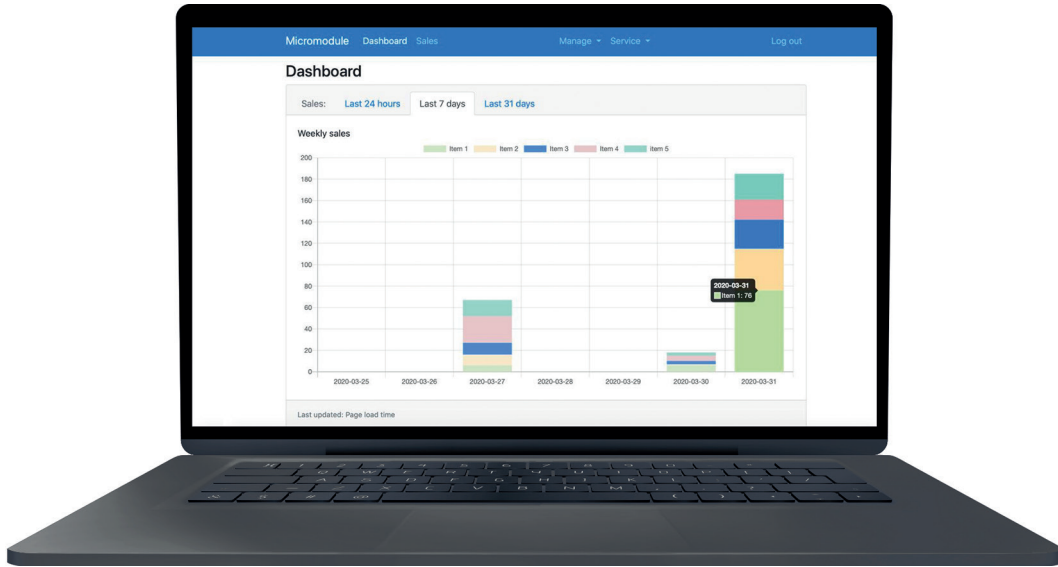

### Sales

Limit: 0 From: 2020-03-02 to: 2020-03-02 Search

#	Date and time	Total	Paid	Item(s)
---	---------------	-------	------	---------

---

### Items

Import Export

**1** Power bank 10 000 mAh  
Price: 549.00

**2** Кабель живлення 2м USB Type-C  
Price: 199.00

**3** JBL Наушники  
Price: 765.00

Світлодіод

#### Edit Item

Hidden

Name (Українська): Кабель живлення 2м USB Type-C

Description (Українська):

Price: 199

SKU: Кабель\_живлення\_2м\_USB\_Type-C

---

### Languages

This item is only editable from remote server.

**1** Українська

**2** Deutsch

**3** English

**4** Русский

#### Edit Language

Code: uk-UA

Name: Ukrainian

Local Name:

### Usage sessions

Select a date range: 08.08.2024 - 08.08.2024 Today

Id	Date	Duration	Interaction count
TvyQvR2S4ITSQZkFC4iwQ	08/08/24 11:19	1 min 54 sec	12
EHCQmV-T12cTND0wvtG3Q	08/08/24 11:17	1 min 2 sec	10
6mPSBmBmIc2HbrgkUDnwNg	08/08/24 07:35	2 min 26 sec	7
rxLrPAxUQNgFN7xMDv7ug	08/08/24 07:06	3 min 30 sec	1

Clear data Items per page: 25 1-4 of 4

---

### Sales

Select a date range: 08.08.2024 - 08.08.2024 Today

Sale Id	Date	Total Paid	Total Item(s) Price	Transactions	Sold Items
6233a0d02b96fa8	08/08/24 11:18	24	24	Cashless: 24	Haniis_Fanta_Orange_0.33l: 24 x 1
682ea2c0e1cb0cc	08/08/24 11:17	26	26	Cashless: 26	Моршинська_Лимонад_Грейнфрут_1.28 x 1
394a921c9f0a-b9f	08/08/24 07:33	22	22	Cashless: 22	Snickers: 22 x 1

Clear data Export Items per page: 25 1-3 of 3

Management panel

All our machines are connected to Telemetry which allows to monitor sales statistics, the stock status, the fridge temperature ect.

**Dashboard**

Status: Up System since: 2024/08/06 12:48 Change available: 10:55 unavailability items: 127 Error list:

fiscal status: AVAILABLE

cashless status: AVAILABLE

Select a date range: 09.08.2024 - 09.08.2024 Today

Sales this day

Stock

Device: Storage (0125000000000000)

Groups: 55

Full: 0

Empty: 5



# LIFT

The LIFT machine – thanks to its elevator mechanism, it can dispense any items, even those requiring delicate handling (meals, drinks in glass containers, electronics, etc.)



Video

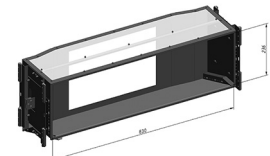
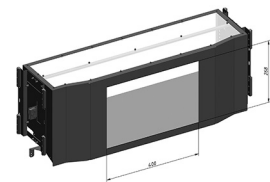
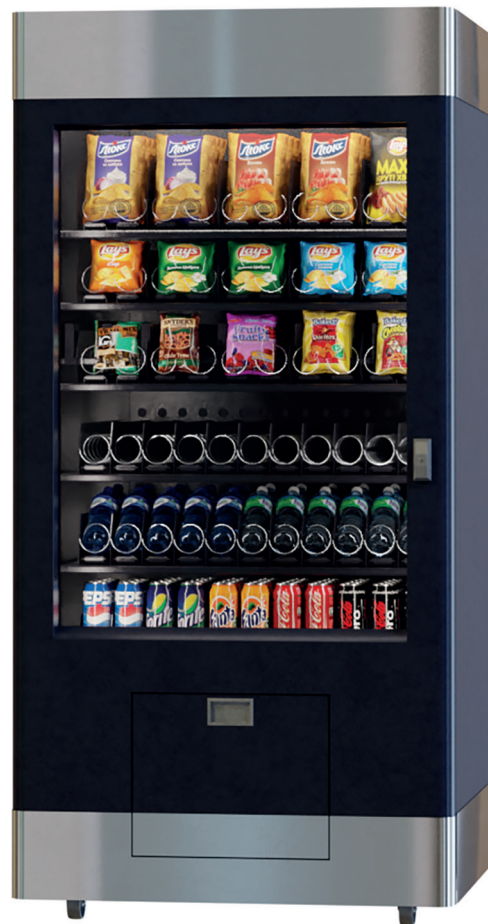

Elevator system basket

- Max. quantity of goods 480 pcs
- Modular architecture – the ability to freely combine different models
- Connection of up to 32 machines to one selection and payment module
- Combination of different dispensing systems in one machine: conveyors, pushers, spirals
- Adjustable shelves height
- Lift dispensing system for delicate items
- Option of refrigeration/heating, maintaining the desired temperature
- Infrared product dispensing sensor
- Modern design, energy-efficient LED lighting
- Dispensing mechanisms made of galvanized steel
- Decorative elements made of stainless steel

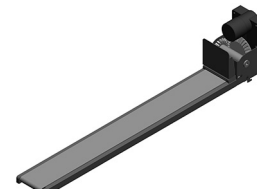
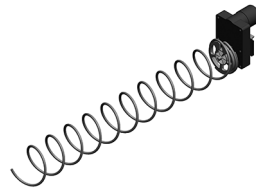
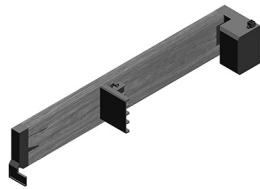

Model <b>LIFT</b>	
Dimensions (HxWxD) (mm)	1830 x 1000 x 1000
Weight (kg)	367
Shelves numbers	from 6 or customised
Dimensions shelves WxD (mm)	850 x 500
Power supply	223 – 230 W, 50 HZ
Max. consumption (Watt)	50 without CU 400 with CU
Terms of use	T= +10...+25°C, RH<70%
Options	<ul style="list-style-type: none"> <li>• Cooling unit (CU) 350 W</li> <li>• Height 2060 mm, + 1-2 shelves</li> <li>• Stainless steel decorative panels</li> <li>• Height 2060 mm</li> <li>• Wheels instead of legs</li> </ul>
Customisation	<ul style="list-style-type: none"> <li>• Choosing the colour and type of paint</li> <li>• Different forks of the dispensing system in one machine due to laser control in the Elevator System</li> <li>• Logo can be created in different versions</li> </ul>



# CRYSTAL

Flower vending machine for 23 compartments with built-in payment module and 19" screen without payment terminal, MDB and wireless communication module. The CRYSTAL machine is also good for selling gift sets, cosmetics, cakes and more.



- Solutions for selling a wide range of goods
- Modern design
- Power Led illumination with Energy Saving
- Built-in module of selection and payment
- Compartment opening sensors
- Cooling option
- Has the capability to print fiscal receipts
- Additional earning opportunities: include a touchscreen display for showcasing commercials



### Model **CRYSTAL**

Dimensions (HxWxD) (mm)	2415 x 1725 x 890
Weight (kg)	421
Cells numbers	23
Cells dimentions HxWxD (mm)	23: 330 x 270 x 330
Power supply	220 – 230 W, 50 HZ
Max. consumption (Watt)	200 witout CU 750 with CU
Terms of use	T= +10...+25°C, RH<70%
Options	<ul style="list-style-type: none"> <li>• Cooling unit (CU) Power: 550 W Coling power: 1200 W +50 kg Inside tempereture: 5...15</li> <li>• Stainless steel decorative panels</li> <li>• Wheels instead of feet</li> <li>• MDB wafer</li> <li>• Wi-Fi router</li> </ul>
Customisation	<ul style="list-style-type: none"> <li>• <b>19" monitor and UPS integrated</b></li> <li>• Choosing the colour and type of paint</li> <li>• Production to customer's own dimensions is possible</li> <li>• Integration of monitors with other sizes is possible</li> <li>• Logo can be created in different versions</li> <li>• Different types of payment systems can be installed or prepared for installation: NFC, coins, banknotes, thermal printer, etc</li> </ul>



# LINK

Locker type vending machine with separate compartments and metal doors.

The Link vending machine can function as an automated postal station (parcel locker), serves as a hub for receiving and dispensing small shipments (orders from online stores and remote trading companies, document packages, corporate client shipments).



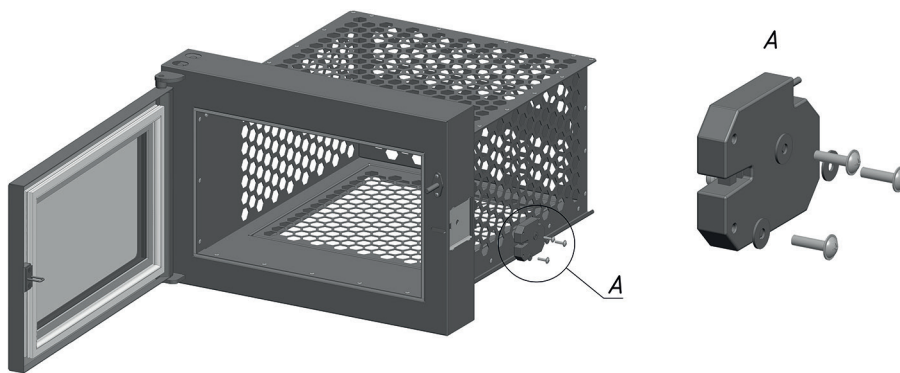

Model <b>LINK</b>	<b>LINK 6</b>	<b>LINK 8</b>	<b>LINK 9</b>	<b>LINK 12</b>	<b>LINK 15</b>	<b>LINK 20</b>
Dimensions (HxWxD) (mm)	2330x1620x685	2330x1620x685	2330x1620x685	2330x1620x685	2330x1620x685	2330x1620x685
Weight (kg)	407	306	432	461	484	514
Cells numbers	6	8	9	12	15	20
Cells dimentions HxWxD (mm)	6: 740x390x490	8: 300x320x490	6: 520x390x490 3: 280x390x490	12: 300x390x490	15: 210x390x490	20: 210x260x490
Power supply	220 – 230 W, 50 HZ					
Max. consumption (Watt)	50 without CU 400 with CU					
Terms of use	T= +10...+25°C, RH<70%					
Options	<ul style="list-style-type: none"> <li>• Cooling unit (CU) Power: 350 W Cooling power: 850 W +50 kg Inside temperature: 5...15</li> <li>• Stainless steel decorative top panels</li> <li>• Wheels instead of feet</li> </ul>					
Customisation	<ul style="list-style-type: none"> <li>• Choosing the colour and type of paint</li> <li>• Production to customer's own dimensions is possible</li> <li>• Logo can be created in different versions</li> </ul>					



# LINK GLASS

Link Glass – locker type machine with separate compartments and glass doors for visual assessment of goods.

The system of separate cells reliably protects each goods.

Electromechanical locks and refrigeration unit can be installed.

Requires installation of a free-standing payment module or integration of TOUCH M into one of the cells.

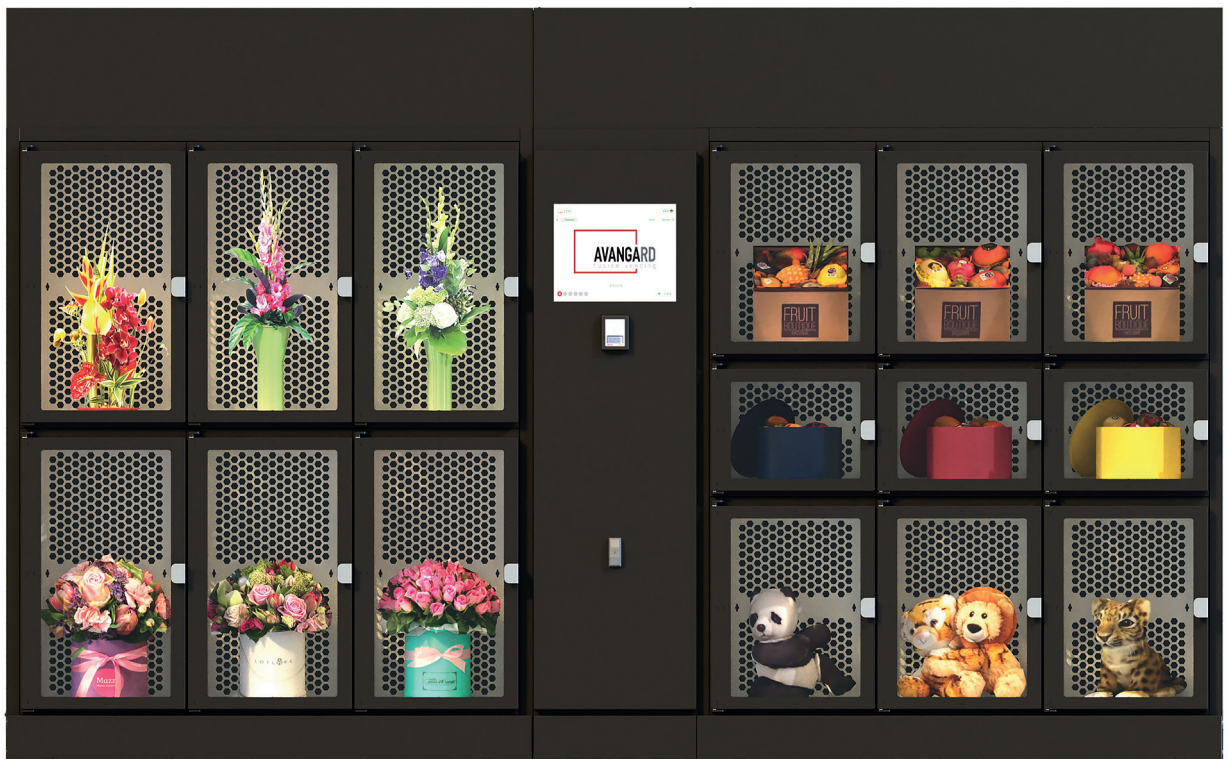

At Avangard, we stand out from other vending machine manufacturers because we don't just sell standard models. All our machines are fully customizable and can be tailored to the needs of your business:

- adjust the size and number of cells (Link and Link Glass)
- install touch monitors of almost any size
- color, branding, additional equipment (for example, a roof for outdoor machines)

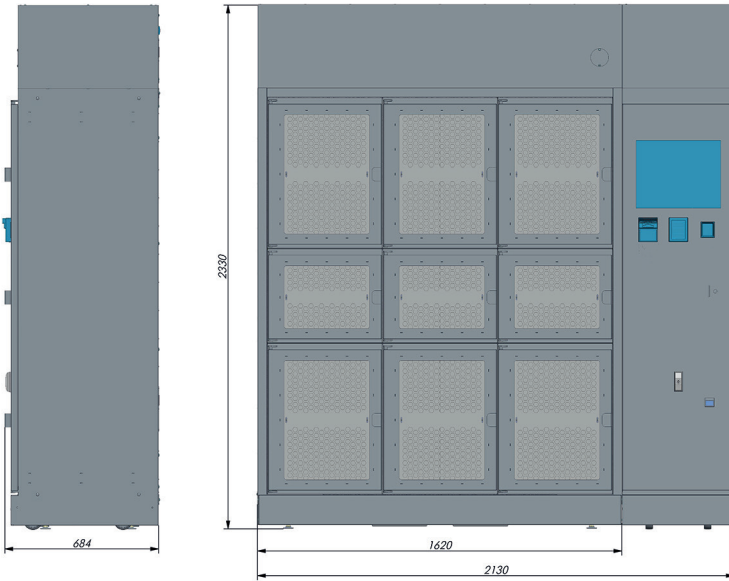

Model <b>LINK GLASS</b>	<b>LINK GLASS 6</b>	<b>LINK GLASS 8</b>	<b>LINK GLASS 8</b>		<b>LINK GLASS 9</b>			<b>LINK GLASS 10</b>		<b>LINK GLASS 12</b>	<b>LINK GLASS 15</b>	<b>LINK GLASS 20</b>	
Dimensions (mm)													
Height	2330	2330	2330		2330			2330		2330	2330	2330	
Width	1620	1000	1620		1620			2132		1620	1620	1620	
Depth	685	685	685		685			685		685	685	685	
Weight (kg)	411	306	431		419			538		443	468	494	
Cells numbers	6	8	8		9			10		12	15	20	
Cells dimensions (mm)	6:	8:	4:	2:	2:	6:	3:	4:	2:	4:	12:	15:	20:
Height	740	300	520	280	740	520	280	520	280	740	300	210	210
Width	390	320	390	390	390	390	390	390	390	390	390	390	260
Depth	490	490	490	490	490	490	490	490	490	490	490	490	490
Power supply	220 – 230 W, 50 HZ												
Max. consumption (Watt)	50 without CU 400 with CU												
Terms of use	T= +10...+25°C, RH<70%												
Options	<ul style="list-style-type: none"> <li>Cooling unit (CU) Power: 350 W Cooling power: 850 W +50 kg Inside temperature: 5...15</li> <li>Stainless steel decorative top panels</li> <li>Wheels instead of feet</li> </ul>												
Customisation	<ul style="list-style-type: none"> <li>Choosing the colour and type of paint</li> <li>Production to customer's own dimensions is possible</li> <li>Logo can be created in different versions</li> </ul>												



# AXON

A versatile and compact vending machine for the retail sale of several types of small goods.

Thanks to its dimensions, it allows you to create an automatic point of sale that works 24/7 where there is no possibility of placing standard-sized machines



- at entrance groups to premises
- on stairwells
- near receptions
- in niches and near elevators



Video

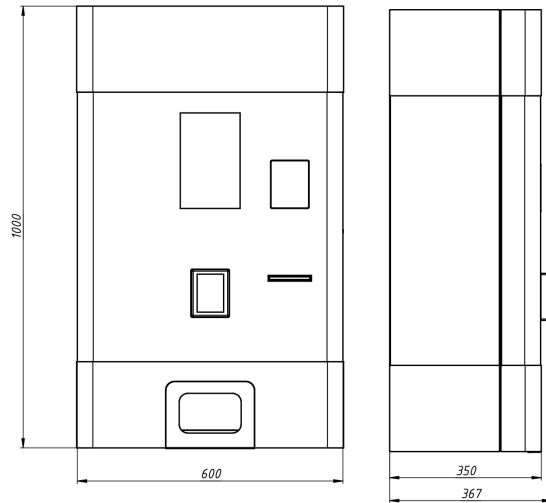

Model <b>AXON</b>	Model <b>AXON T</b>	Model <b>AXON TL</b>
Dimensions (HxWxD) (mm)	1000 x 600 x 350	
Weight (kg)	65	60
Monitor size	19	10
Dispensing system	6 tubes of 35 products (68 x 73 x 18) or according to the product line	
Power supply	220 – 230 W, 50 HZ	
Max. consumption (Watt)	70	50
Terms of use	T= +10...+25°C, RH<70%	
Options	<ul style="list-style-type: none"> <li>• Stainless steel decorative panels</li> <li>• MDB wafer</li> <li>• Wi-Fi router</li> <li>• Stand for Axon without wheels</li> <li>• Stand for Axon with wheels</li> </ul>	
Customisation	<ul style="list-style-type: none"> <li>• Choosing the colour and type of paint</li> <li>• Integration of monitors with other sizes is possible</li> <li>• Logo can be created in different versions</li> <li>• Different types of NFC can be installed or prepared for installation</li> </ul>	



# E-CIGARETTE VENDING MACHINE

Vending machines for disposable electronic cigarettes (vape vending machine)

Our proprietary AVANGARD Atomic SW software allows us to remotely monitor:

- the performance of machines
- sales volume
- product assortment in each machine
- other essential metrics

The machines are equipped with an age verification system, restricting purchases to individuals over 18 years old, following European documentation standards

- Stylish and Modern Design
- Vape Vending Machines Seamlessly Blend Into Any Interior
- Option to Install the Terminal on a Special Stand to Limit Damage to Facades
- Minimal Energy Consumption

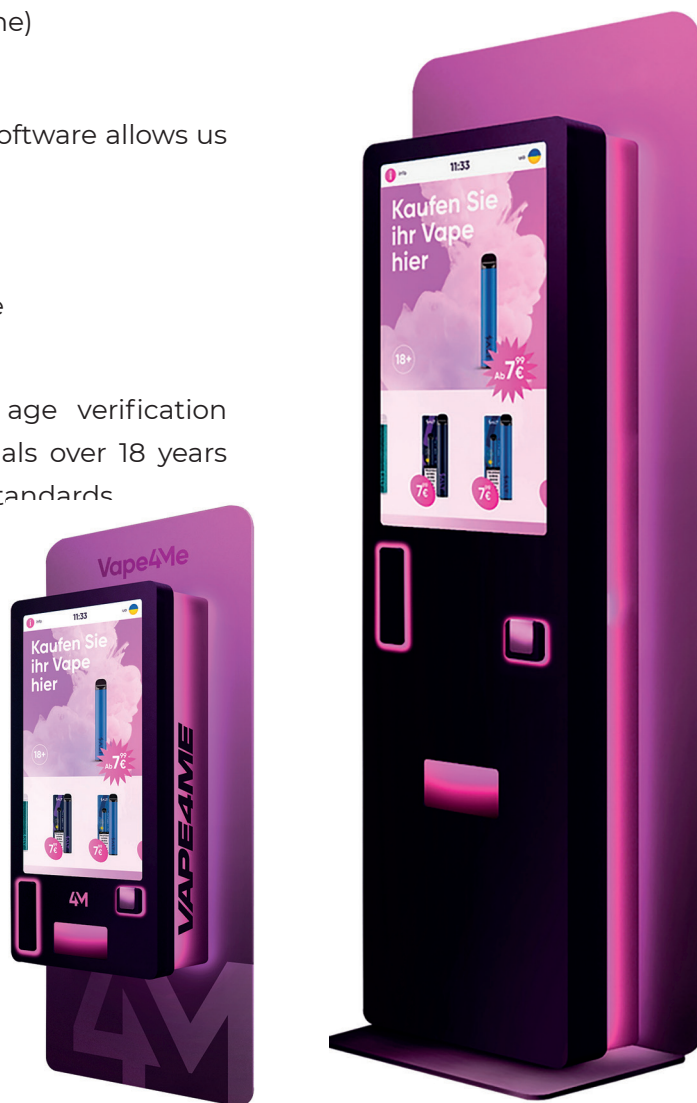

Model <b>VAPE MACHINE</b>	<b>VAPE MACHINE 100</b>	<b>VAPE MACHINE 200</b>	<b>VAPE MACHINE 300</b>
Dimensions (HxWxD) (mm)	750x500x230	1494x665x303	1853x665x303
Weight (kg)	50	70	90
Quantity of dispensers	6	16	18
Power supply	228 – 230 W, 50 HZ	229 – 230 W, 50 HZ	230 – 230 W, 50 HZ
Max. consumption, Watt	30	40	40
Terms of use	T = -10 ... +30 OC, RH<80%		
Options	<ul style="list-style-type: none"> <li>• MDB</li> <li>• Wi-Fi router</li> <li>• Stainless steel decorative panels</li> <li>• Bill printer</li> <li>• Cash/coin acceptor</li> </ul>		
Customisation	Touchscreen monitor 27 Age verification by ID card, passport, rights, Girocard	Touchscreen monitor 32 Age verification by ID card, passport, rights, Girocard	



# TOUCH 10, 19

Payment module for use with Link Glass, Link, and QUBE vending machines, as well as in combination with other vending machines in a smart-shop. The module has a monitor, a built-in computer, and the necessary wiring to integrate it with the corresponding vending machine.

The module does not include a payment terminal, MDB, or wireless communication module, which is selected separately according to the order.



- Connection of up to 32 machines to one selection and payment module
- Based on a 64-bit computer
- Versatility of payment methods (card, smartphone, banknotes)
- EVA-mount NFC card reader
- Printing of receipts (including fiscal)
- Remote management system
- Multilingual user-friendly interface
- Bright touchscreen display
- Possibility of integration with other systems



Model <b>TOUCH for LINK</b>	<b>TOUCH I-10</b>	<b>TOUCH I-19</b>	<b>TOUCH 10</b>	<b>TOUCH 19</b>
Dimensions (HxWxD) (mm)	Integrated	Integrated	2330x250x1000	2330x500x1000
Weight (kg)	30	50	150	200
Monitor size	10	19	10	19
Power supply	220 – 230 W, 50 HZ			
Max. consumption (Watt)	<ul style="list-style-type: none"> <li>• 100 – 10"</li> <li>• 150 – 19"</li> </ul>			
Terms of use	T= +10...+25°C, RH<70%			
Options	<ul style="list-style-type: none"> <li>• Stainless steel decorative top panel</li> <li>• Wheels instead of feet</li> <li>• MDB wafer</li> <li>• Wi-Fi router</li> </ul>			
Customisation	<ul style="list-style-type: none"> <li>• Choosing the colour and type of paint</li> <li>• Integration of monitors with other sizes is possible</li> <li>• Logo can be created in different versions</li> <li>• Different types of payment systems can be installed or prepared for installation: NFC, coins, banknotes, thermal printer, etc.</li> </ul>			

Model <b>TOUCH for LIFT</b>	<b>TOUCH S</b>	<b>TOUCH M</b>	<b>TOUCH 10</b>	<b>TOUCH 19</b>
Dimensions (HxWxD) (mm)	500x250x500	390x320x80	2330x250x685	2330x500x685
Weight (kg)	50	50	150	200
Monitor size	10	10	10	19
Power supply	220 – 230 W, 50 HZ			
Max. consumption (Watt)	<ul style="list-style-type: none"> <li>• 100 – 10"</li> <li>• 150 – 19"</li> </ul>			
Terms of use	T= +10...+25°C, RH<70%			
Options	<ul style="list-style-type: none"> <li>• Stainless steel decorative panels</li> <li>• Wheels instead of feet</li> <li>• MDB wafer</li> <li>• Wi-Fi router</li> </ul>			
Customisation	<ul style="list-style-type: none"> <li>• Choosing the colour and type of paint</li> <li>• Integration of monitors with other sizes is possible</li> <li>• Logo can be created in different versions</li> <li>• Different types of payment systems can be installed or prepared for installation: NFC, coins, banknotes, thermal printer, etc.</li> </ul>			



# SMARTSHOP

Smartshop is an automated point of sale (microstore) without a salesperson. Smartshop allows the consumer to browse, choose a variety of food, beverages and other goods, and pay with cash or bank card.

AVANGARD specialists can develop an individual model of a turnkey autonomous microstore.



- Fresh, frozen and chilled foods, hot and cold drinks, snacks and more
- Advanced payment systems ensure safe and hassle-free transactions
- Product availability and expiration dates are monitored through software that provides real-time information
- Data can be tracked on a computer or smartphone

SMARTSHOP	
Power supply	226 – 230 W, 50 HZ
Max. consumption (Watt)	200
Terms of use	T= -10...+30°C, RH<80%
Options	<ul style="list-style-type: none"> <li>• MDB</li> <li>• Wi-Fi router</li> <li>• Stainless steel decorative panels</li> <li>• Bill printer</li> <li>• Cash/coin acceptor</li> </ul>



# SMARTFOODCOURT

Transform your vending machine into a self-service smartfoodcourt.

The Microwave Rank is compatible with all AVANGARD vending machines, with the Qube Lift machine being the top recommendation.

Enjoy time-saving parallel purchasing: while one oven heats a meal, another customer can make their purchase. Automated 24/7 points of sale of restaurant dishes with the possibility of issuing previously made/paid orders.

Each module (microwave ovens, selection and payment module, etc.) can be ordered separately and connected to any other device of the AVANGARD models.

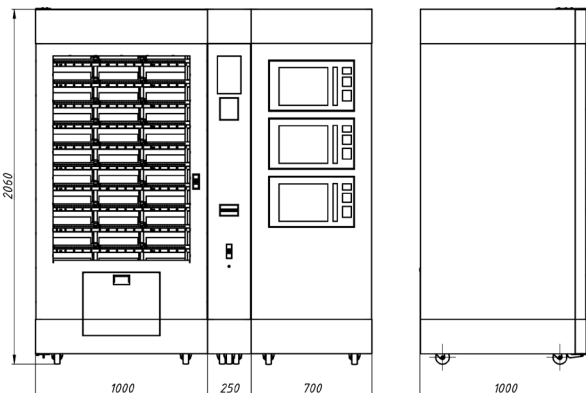

SMARTFOODCOURT	
Power supply	227 – 230 W, 50 HZ
Max. consumption (Watt)	200
Terms of use	T= -10...+30°C, RH<80%
Options	<ul style="list-style-type: none"> <li>• MDB</li> <li>• Wi-Fi router</li> <li>• Stainless steel decorative panels</li> <li>• Bill printer</li> <li>• Cash/coin acceptor</li> </ul>
Customisation	MW Rank



# CUSTOMIZED SOLUTIONS

## LINK GLASS 63

The 63-compartment vending machine (locker type), a fully customized unit designed specifically for our VIP client from Belgium.

- Customers can conveniently pick up their purchases right from the street, as the locker is loaded from the back.
- The machine comes with a built-in payment system, featuring all the necessary controllers and payment systems for the consumer.
- A monitor and secure software are included with the machine.





# CUSTOMIZED SOLUTIONS

## FLOWER VENDING MACHINE with 12 cells

Unique and exclusive design of our partners, reproduced by AVANGARD specialists in metal – Link Glass customized version.

The system is equipped with refrigerator, 10-inch touch screen for product selection, contactless payment system, as well as a bill acceptor. The proprietary software and telemetry allow for complete tracking of product refills and sales.



*Need something **UNIQUE**? Our dedicated R&D department can create a completely custom device just for you. Plus, our machines feature strong, vandal-resistant construction with thick steel and magnetic lockers*



# NOTES

A series of horizontal dashed lines for writing notes.



# NOTES

A series of horizontal dashed lines for writing notes.

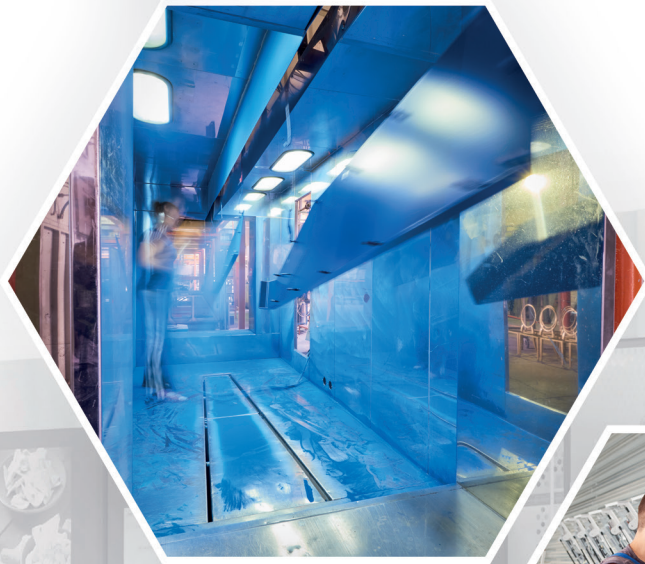

**AVANGARD**  
F U S I O N V E N D I N G

We will be glad to cooperate!

08132 Ukraine, Kyiv region,  
Vyshneve, Kyivska Str, 29

konovalov@avg.com.ua  
www.vending-solution.com  
+38 050 450 4730